

PIPE BRACKET

Type 116 hv-D

height adjustable for pipe supports type DIN 3567 A

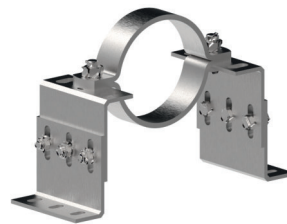
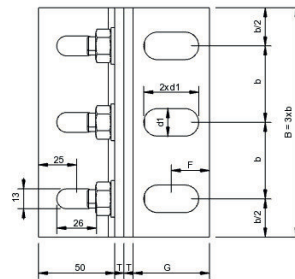
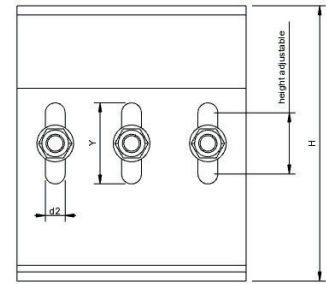
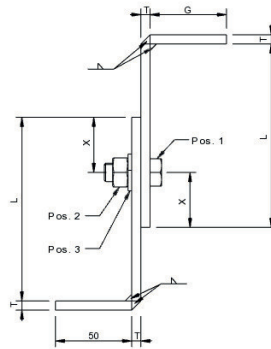
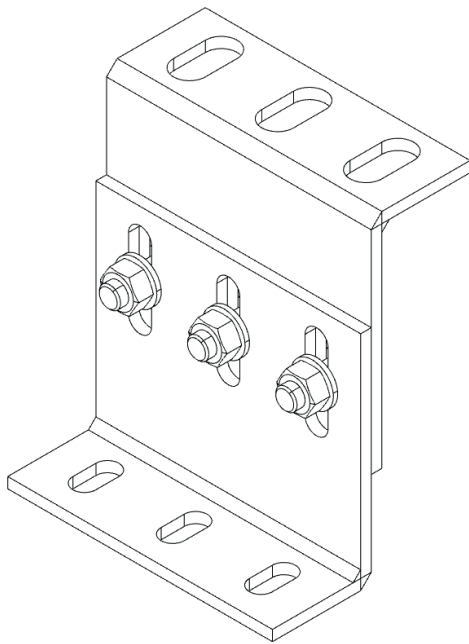

Fix point:
2 x type 116 hv
with 1 piece
type DIN 3567 A

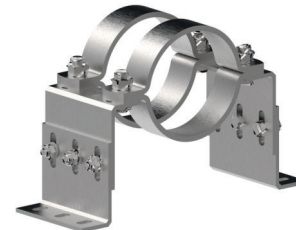

Fix point:
2 x type 116 hv
with 2 pieces
type DIN 3567 A

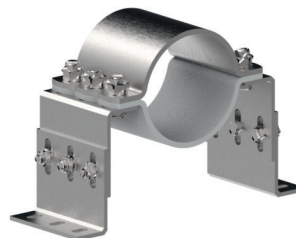

Fix point:
2 x type 116 hv
with 3 pieces
type DIN 3567 A

für Ø	20-49	57-89	108-220	267-368	407-521	610
b	30	40	50	60	80	100
B	90	120	150	180	240	300
d1	11.5	14.0	18.0	23.0	27.0	
d2	11.5		13.0	13.0	18.0	23.0
F	14	18	25	30	40	50
G	40		50	60	80	100
H	95-145		140-220	180-280	250-350	320-460
Height adjustable	± 25		± 40	± 50		± 70
L	80		120	160	200	250
Pos. 1 screw DIN 933	M 10 x 30		M 12x40		M 16 x 40	M 20 x 40
Pos. 2 hex nut DIN 934	M 10		M 12		M 16	M 20
Pos. 3 washer DIN 125	M 10		M 12		M 16	M 20
T	6			8		
X	26	36	53	58	60	
Y	37	53	63	68	93	

Type 116 hv is suitable for
 - 1 piece type 3567 A centered
 - 2 pieces type 3567 A left and right
 - 3 pieces type 3567 A

**Also STAINLESS available
RUST
PROOF**

Specification

Material No. 1.0038, galvanized or hot-dip galvanized. Also deliverable in stainless steel material No. 1.4301 and 1.4571.